



E-3120 TURBINE APPEARANCE AND FINISH

Parrocks Farm,

Bacup,

OL13 9UF















Zone of Theoretical Visibility for the development of 1.no Endurance E-3120 Wind Turbine at Parrock Farm, Todmorden Road, Bacup, Lancashire OL13 9UF

The image represents the Zone of Theoretical Visibility (ZTV) for 1.no Endurance E-3120 Wind Turbine at Parrock Farm. The target height for the ZTV is the turbine nacelle (hub). The data is presented on an OS1:250,000 scale map and uses OS Panorama DTM at the supplied 50m grid size.

This ZTV calculation is centred on the turbine position and extends out over a radius of 20km. It presents a 'bare earth' scenario which takes into account topography but does include the screening effect of structures or vegetation.

The Earth's curvature and light refraction have been included in the calculation and a viewer height of 2m has been assumed.

Three recognised long distance recreational routes (Rossendale Way, Pennine Bridleway and Pennine Way) have been highlighted. The ZTV extends on to small sections of the Rossendale Way (Purple) and the Pennine Bridleway (Red). However, these are over 5km away from the turbine location. At this distance, the development is considered to have a negligible visual impact. There is a section of the Rossendale way over 10km away (West of the development) which falls into the ZTV. Again, at this distance, the development is considered to have a negligible visual impact. The Pennine Way (indicated in brown) falls well outside the ZTV.

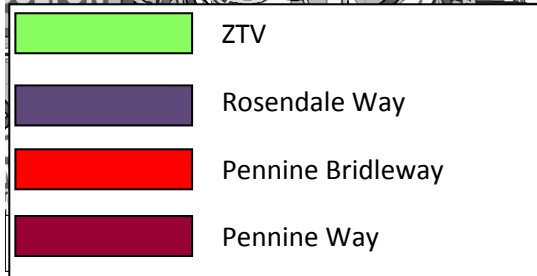
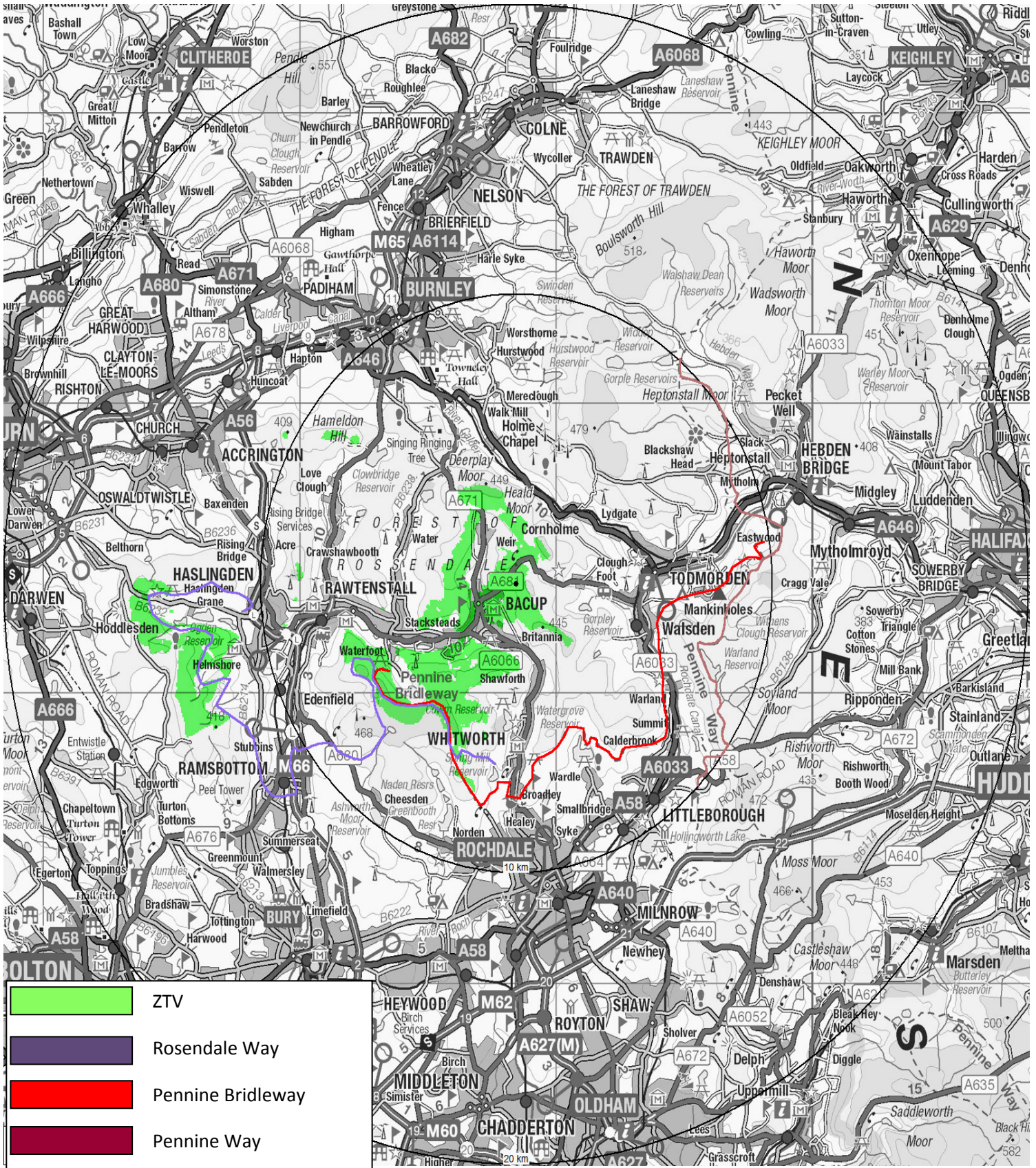

DC21 Limited
 Dene House, North Road,
 Kirkburton, Huddersfield,
 West Yorkshire HD8 0RW

Tel: +44 (0)1484 607 808
 Fax: +44 (0)1484 605 514
 Email: info@dc21group.com
 Web: www.dc21group.com

Registered in England: 6855349
 VAT No. 973 1573 03



PHOTOMONTAGES

Cumulative Visual Assessment to Support Applications 2012/0178 and 2012/0179 for the Amendment to Change from Three Gaia 18m To Hub Wind Turbines to Two Endurance 24.6m to Hub Wind Turbines.

Prepared for DC21 Ltd

25 June 2012



Viewpoint Title:	Parrock Farm from Todmorden Road: Proposed Endurance Turbine with Approved Turbines at Reaps Moss			IMAGE 1 25.06.2012 www.cwp-ltd.com 
Viewpoint Coordinates:	X388036/Y423969	Direction of View	118°	
Horizontal Field of View:	46.5°	Viewing Height:	2m	



Viewpoint Title:	Parrock Farm from Todmorden Road: Approved GAIA Turbines with Approved Turbines at Reaps Moss		IMAGE 2 25.06.2012 www.cwp-ltd.com 	
Viewpoint Coordinates:	X388036/Y423969	Direction of View		118°
Horizontal Field of View:	46.5°	Viewing Height:		2m



Viewpoint Title:	Height Side Farm from Todmorden Road. Proposed Endurance Turbine.			IMAGE 3 25.06.2012 www.cwp-ltd.com 
Viewpoint Coordinates:	X388021/Y423955	Direction of View	329°	
Horizontal Field of View:	46.5°	Viewing Height:	2m	



Viewpoint Title:	Height Side Farm from Todmorden Road. Approved Gaia Turbine.			IMAGE 4 25.06.2012 www.cwp-ltd.com 
Viewpoint Coordinates:	X388021/Y423955	Direction of View	329°	
Horizontal Field of View:	46.5°	Viewing Height:	2m	



Viewpoint Title:	Height Side Farm/Parrock Farm from Bacup Golf Course: Proposed Endurance Turbines with Approved Turbines at Todmorden Moor			IMAGE 5 25.06.2012 www.cwp-ltd.com 
Viewpoint Coordinates:	X386103/Y423254	Direction of View	66.54°	
Horizontal Field of View:	46.5°	Viewing Height:	2m	



Viewpoint Title:	Height Side Farm, Parrock Farm from Bacup Golf Course: Approved GAIA Turbines with Approved Turbines at Todmorden Moor			IMAGE 6 25.06.2012 www.cwp-ltd.com 
Viewpoint Coordinates:	X386103/Y423254	Direction of View	66.54°	
Horizontal Field of View:	46.5°	Viewing Height:	2m	



Viewpoint Title:	Height Side Farm from Todmorden Old Road: Proposed Endurance Turbine with Approved Turbines at Todmorden Moor		IMAGE 7 25.06.2012 www.cwp-ltd.com 	
Viewpoint Coordinates:	X387700/Y423914	Direction of View		50°
Horizontal Field of View:	46.5°	Viewing Height:		2m



Viewpoint Title:	Height Side Farm from Todmorden Old Road: Approved Gaia Turbine with Approved Turbines at Todmorden Moor		IMAGE 8 25.06.2012 www.cwp-ltd.com 	
Viewpoint Coordinates:	X387700/Y423914	Direction of View		50°
Horizontal Field of View:	46.5°	Viewing Height:		2m

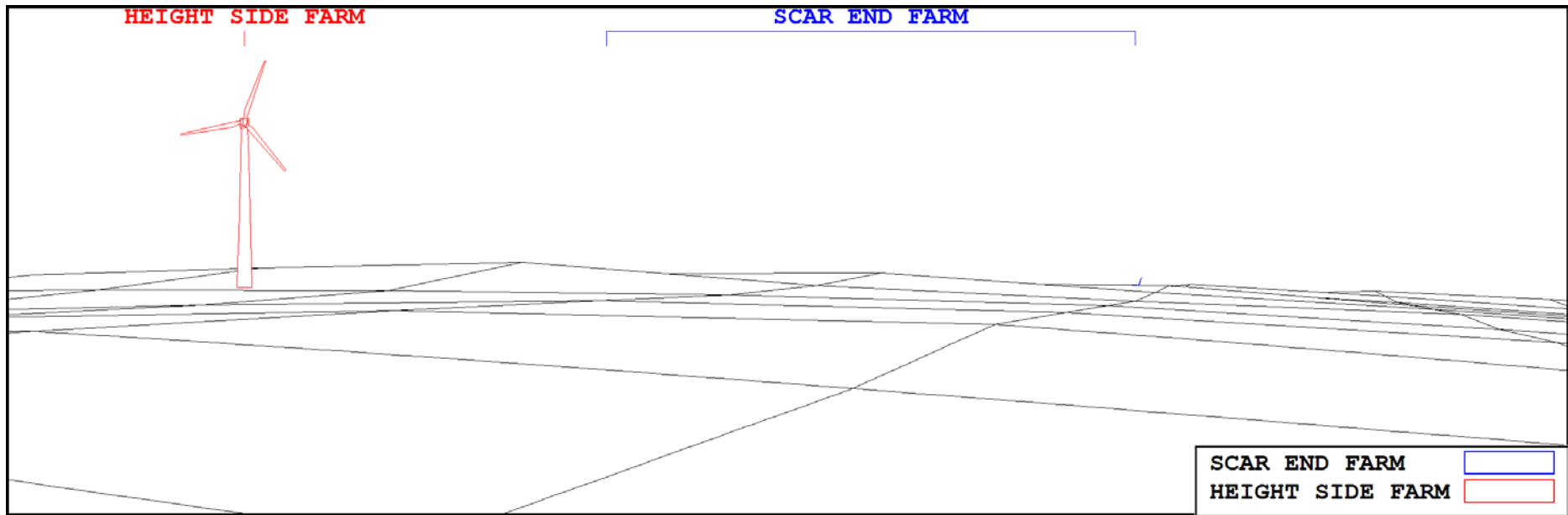

Wire Frame Title:	Height Side Farm from Todmorden Road. Proposed Endurance with Appealed Endurance Turbines at Scar End Farm		IMAGE 8
Viewpoint Coordinates:	X388021/Y423955	Direction of View	345°
Horizontal Field of View:	46.5°	Viewing Height:	10m
			25.06.2012 www.cwp-ltd.com



The wire frame view above is taken from viewing height of 10m AOD. At this significant height only the tip of proposed Turbine #1 at Scar End Farm. From this point on Todmorden Road and at a normal viewing height of around 2m there would be no intervisibility between the proposed development at Height Side Farm and the development currently under appeal at Scar End Farm.

Disclaimer

The information contained herein is believed to be correct at the time of issue, but no liability can be accepted for any inaccuracies. Consulting With Purpose Ltd cannot accept any responsibility for any loss or damage resulting from the use of the material contained herein.

Third Party Disclaimer

Any disclosure of this report to a third party is subject to this disclaimer. The report was prepared by Consulting with Purpose Ltd at the instruction of, and for use by, our client named on the front of the report. It does not in any way constitute advice to any third party who is able to access it by any means.

CWP Ltd
45 New Laithe Hill
Newsome
Huddersfield
HD4 6RF
www.cwp-ltd.com
info@cwp-ltd.com

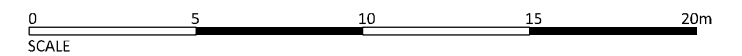
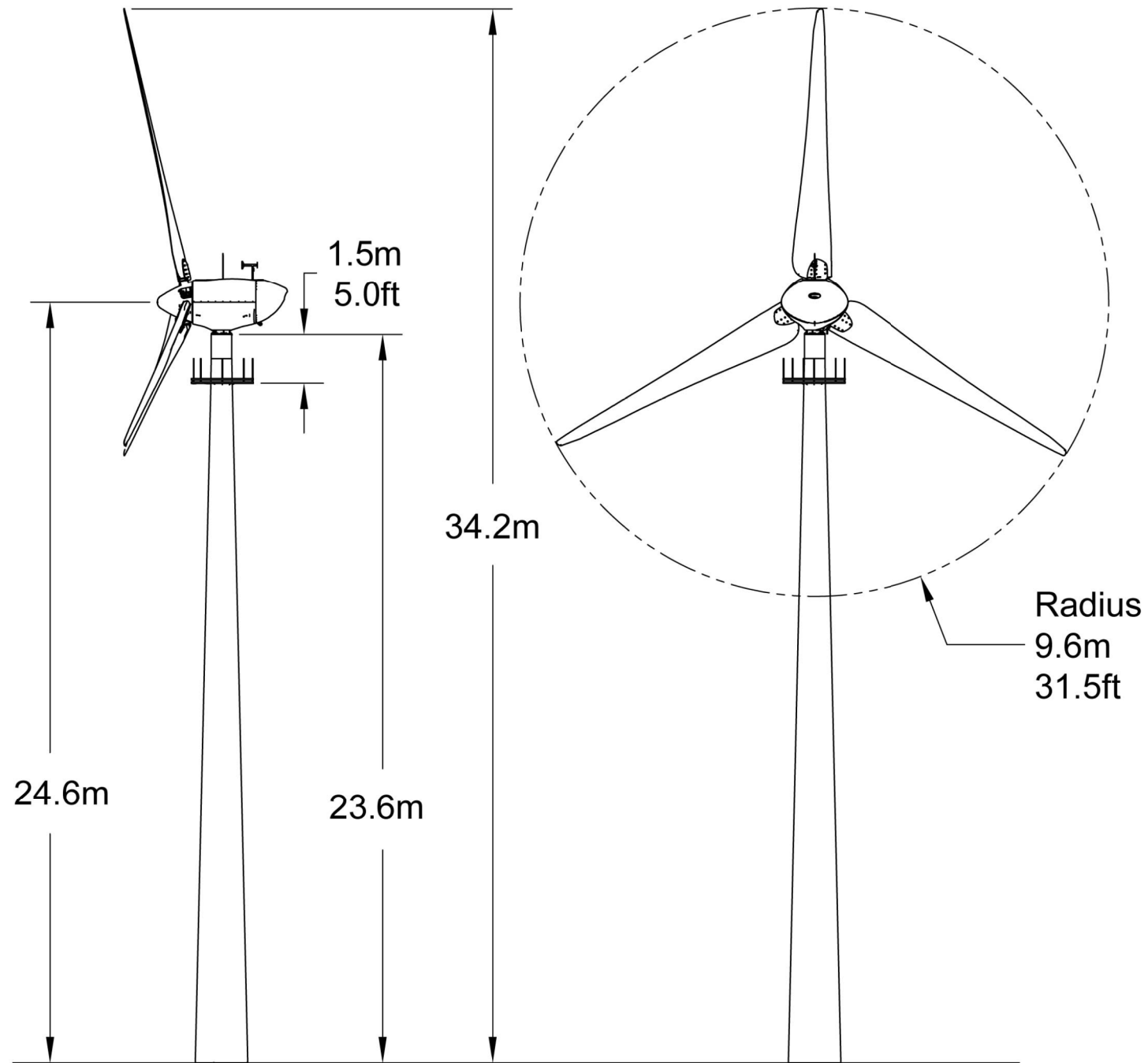

Do not scale this drawing
 DC21 to be notified of discrepancies in figured dimensions
 Contractors must check all dimensions from site
 This drawing is copyright and is for use on this site only
 This drawing is to be used solely for information as entitled
 For other information refer to the latest revision of any cross referenced drawing



REV	DATE	DESCRIPTION	BY
REVISIONS			

PROJECT TITLE WIND TURBINE INSTALLATION AT PARROCK, BACUP			
DRAWING TITLE ELEVATION OF A 50kw MONOPOLE WIND TURBINE			
DRAWING NUMBER 03	REVISION	DATE FEB 12	SCALE NTS
SHEET A3	STATUS PLANNING		
<small>DC21 Ltd, Dene House, North Road, Kirkburton, W. Yorks, HD8 0RW Registered Number: 6855349 www.dc21group.com</small>			



JOB NO.
11149



PHOTOMONTAGES

To aid the planning permission for the installation of one Endurance E-3120 24.6m nacelle height, 9.6m blade radius (50KW) wind turbine located at:

Parrocks Farm,
Bacup,
OL13 9UF





Location Map



- Photo location ●
- Wind Turbine ☒



Image 1 - looking south east from Todmorden Road – distance of 560m



Existing View



Proposed View, Wind Turbine only slightly visible and softened on horizon by surrounding pylons.



Image 2 - looking south west on the intersection of Bacup Road and Todmorden Road – distance of 920m



Existing view



Proposed View – Wind Turbine not visible.



Image 3 - looking North West from Hazel Grove – distance of 700m



Existing View



Proposed View – Wind Turbine barely visible, softened by existing pylons on horizon.

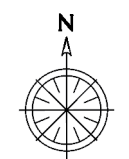
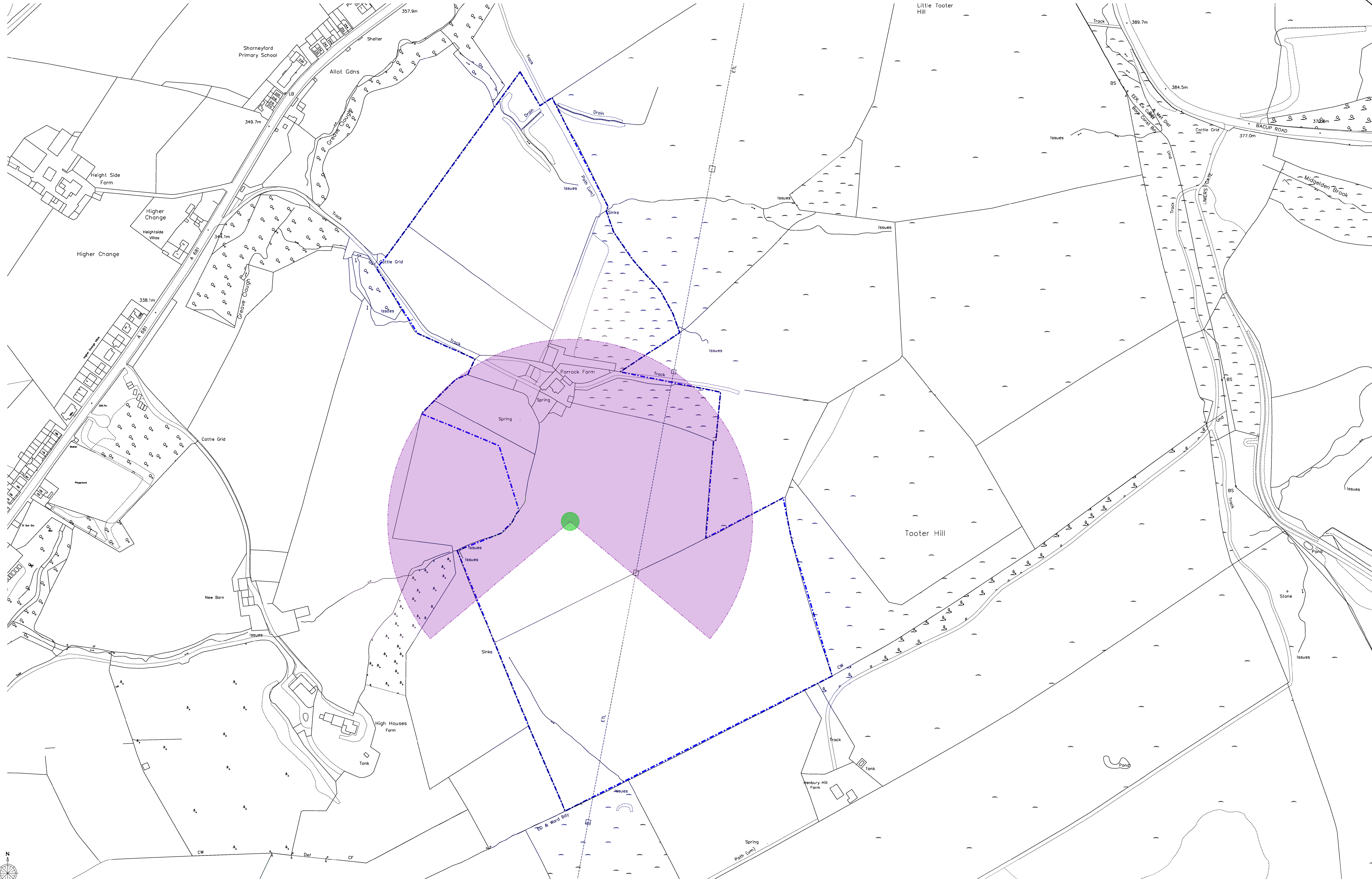

Do not scale this drawing
 without permission from the author of this drawing
 Contractors must check all dimensions from this
 drawing is copyright and for use on the site only.
 This drawing is to be used for information as advised
 for other information refer to the latest revision of any other referenced drawing.

LOCATION PLAN

NOTES

- WIND TURBINE
- SITE OWNERSHIP BOUNDARY



PROJECT TITLE WIND TURBINE INSTALLATION AT PARROCK, BAGCUP			
DRAWING TITLE SHADOW FLICKER			
DRAWING NUMBER 05	REVISION	DATE MAR 12 11:25:0	SCALE
SHEET A0	STATUS PLANNING		



REV	DATE	DESCRIPTION	BY